

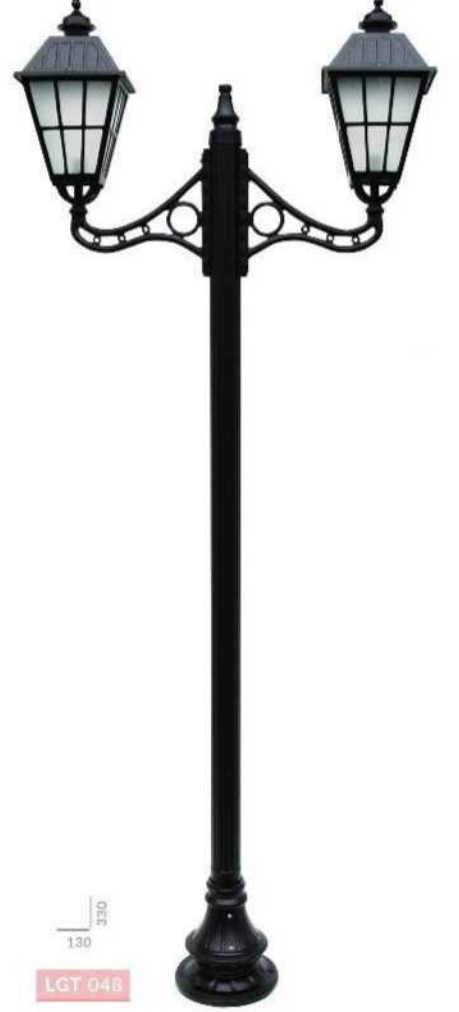

E-mail: marco.vision@yahoo.com, Telefon: +40 761066656

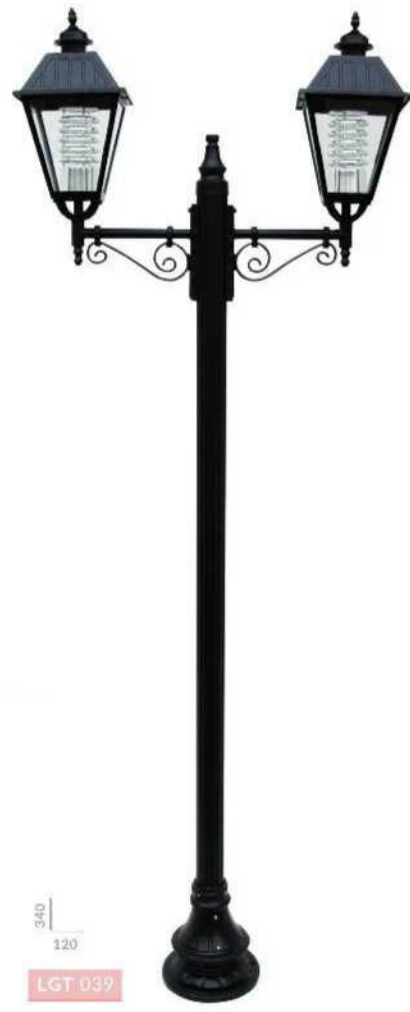



- E27
- Aluminium Casting
- Electrostatic Painting
- IP55
- 230 V 50 Hz
- ISO 9001:2015
- TSE
- CE

- CE
- TSE
- ISO 9001:2015
- 230 V 50 Hz
- IP55
- Electrostatic Painting
- Aluminium Casting
- E27

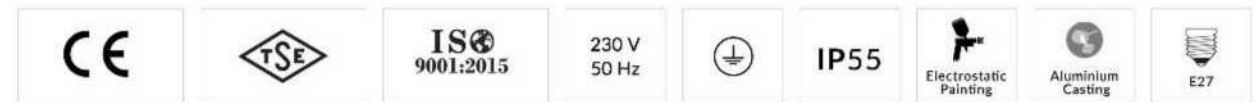

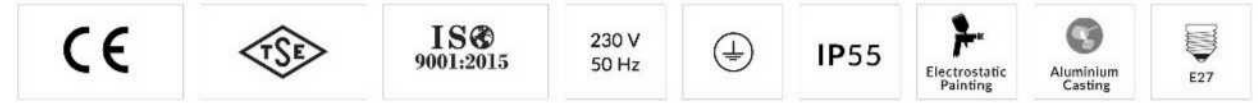
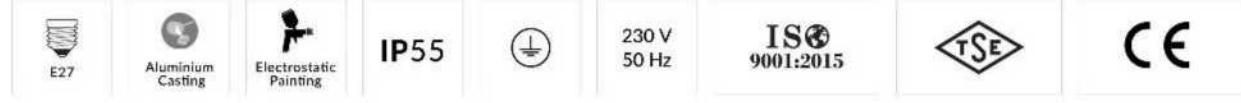



LGT 067
280
95



LGT 069
68
27



LGT 071
65
47



LGT 072
50
78



LGT 073
120
30



LGT 074
280
95



LGT 068
120
27



LGT 070
76
27

-
-
-
-
-
-
-
-
-
-
-
-
-
-
-
-
-
-



LGT 075
265
85



LGT 077
68
25



LGT 079
40
38



LGT 081
38
57



LGT 083
280
90



LGT 076
38
25



LGT 078
100
25



LGT 080
36
40



LGT 082
38
25

E27 Aluminium Casting Electrostatic Painting IP55 230 V 50 Hz ISO 9001:2015 TSE CE

CE TSE ISO 9001:2015 230 V 50 Hz IP55 Electrostatic Painting Aluminium Casting E27





65
25

60
42

90
38

60
25

105
25

50
25

175
25

260
90

E27	Aluminium Casting	Electrostatic Painting	IP55		230 V 50 Hz	ISO 9001:2015		CE	CE		ISO 9001:2015	230 V 50 Hz		IP55	Electrostatic Painting	Aluminium Casting	E27
-----	-------------------	------------------------	------	--	----------------	---------------	--	----	----	--	---------------	----------------	--	------	------------------------	-------------------	-----



LGT 103
240
85



LGT 105
55
20



LGT 107
45
25



LGT 109
30
46



LGT 104
55
20



LGT 106
100
20



LGT 108
40
60



LGT 110
20
100



LGT 111
90
250

-
-
-
-
-
-
-
-
-
-
-
-
-
-
-
-
-
-

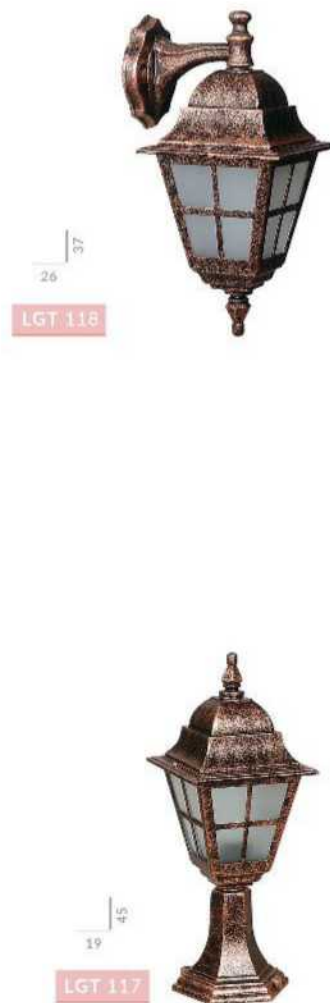



E27
 Aluminum Casting
 Electrostatic Painting
 IP55

 230 V 50 Hz
 ISO 9001:2015
 TSE
 CE

CE
 TSE
 ISO 9001:2015
 230 V 50 Hz

 IP55
 Electrostatic Painting
 Aluminum Casting
 E27



E27
 Aluminum Casting
 Electrostatic Painting
 IP55

 230 V 50 Hz
 ISO 9001:2015
 TSE
 CE

CE
 TSE
 ISO 9001:2015
 230 V 50 Hz

 IP55
 Electrostatic Painting
 Aluminum Casting
 E27



- E27
- Aluminium Casting
- Electrostatic Painting
- IP55
- 230 V 50 Hz
- ISO 9001:2015
- TSE
- CE

- CE
- TSE
- ISO 9001:2015
- 230 V 50 Hz
- IP55
- Electrostatic Painting
- Aluminium Casting
- E27



LGT 152



LGT 154



LGT 156



LGT 158



LGT 160



LGT 162



LGT 153



LGT 155



LGT 156



LGT 159



LGT 161



LGT 163

			IP55		230 V 50 Hz	ISO 9001:2015		CE	CE		ISO 9001:2015	230 V 50 Hz		IP55			
--	--	--	------	--	----------------	------------------	--	----	----	--	------------------	----------------	--	------	--	--	--



260
80
LGT 164



265
95
LGT 166



280
68
LGT 168



370
110
LGT 170



260
90
LGT 172



230
80
LGT 174



265
90
LGT 165



260
76
LGT 167



275
55
LGT 169



260
77
LGT 171



273
60
LGT 173



290
84
LGT 175

E27 Aluminium Casting Electrostatic Painting IP55 230 V 50 Hz ISO 9001:2015 TSE CE

CE TSE ISO 9001:2015 230 V 50 Hz IP55 Electrostatic Painting Aluminium Casting E27



310
110

LGT 176



300
115

LGT 178



310
110

LGT 180



450
110

LGT 182



450
110

LGT 184



450
60

LGT 186



340
45

LGT 177



300
50

LGT 179



300
30

LGT 181



350
130

LGT 183



350
110

LGT 185



450
120

LGT 187



E27



Aluminum Casting



Electrostatic Painting

IP55



230 V
50 Hz

ISO
9001:2015



ISO
9001:2015

230 V
50 Hz



IP55



Electrostatic Painting



Aluminum Casting



E27





LED	Aluminium Casting	Electrostatic Painting	IP55	⏚	230 V 50 Hz	ISO 9001:2015	TSE	CE	CE	TSE	ISO 9001:2015	230 V 50 Hz	⏚	IP55	Electrostatic Painting	Aluminium Casting	LED
-----	-------------------	------------------------	------	---	----------------	---------------	-----	----	----	-----	---------------	----------------	---	------	------------------------	-------------------	-----



700
270

LGT 213



700
270

LGT 214



800
250

LGT 216



600
270

LGT 212



600
270

LGT 215



1000
350

LGT 217



700
150

LGT 218

LED



Aluminum Casting



Electrostatic Painting

IP65



230 V
50 Hz

ISO
9001:2015



CE

CE



ISO
9001:2015

230 V
50 Hz



IP65



Electrostatic Painting



Aluminum Casting

LED

400
30

LGT 219



LED	Aluminium Casting	Electrostatic Painting	IP65	⏚	230 V 50 Hz	ISO 9001:2015	TSE	CE
-----	-------------------	------------------------	------	---	----------------	------------------	-----	----

200
150

LGT 220



CE	TSE	ISO 9001:2015	230 V 50 Hz	⏚	IP65	Electrostatic Painting	Aluminium Casting	LED
----	-----	------------------	----------------	---	------	------------------------	-------------------	-----

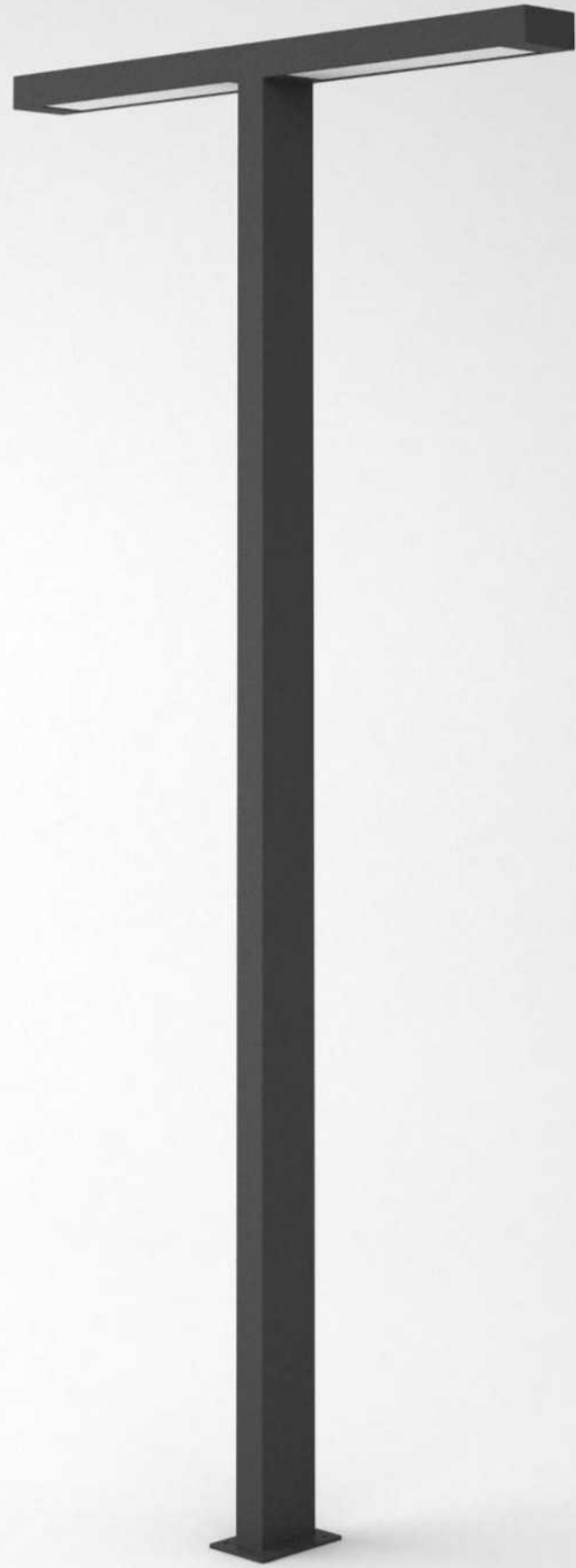

400
150

LGT 221

LED	Aluminium Casting	Electrostatic Painting	IP65	⏚	230 V 50 Hz	ISO 9001:2015	TSE	CE
-----	-------------------	------------------------	------	---	----------------	------------------	-----	----

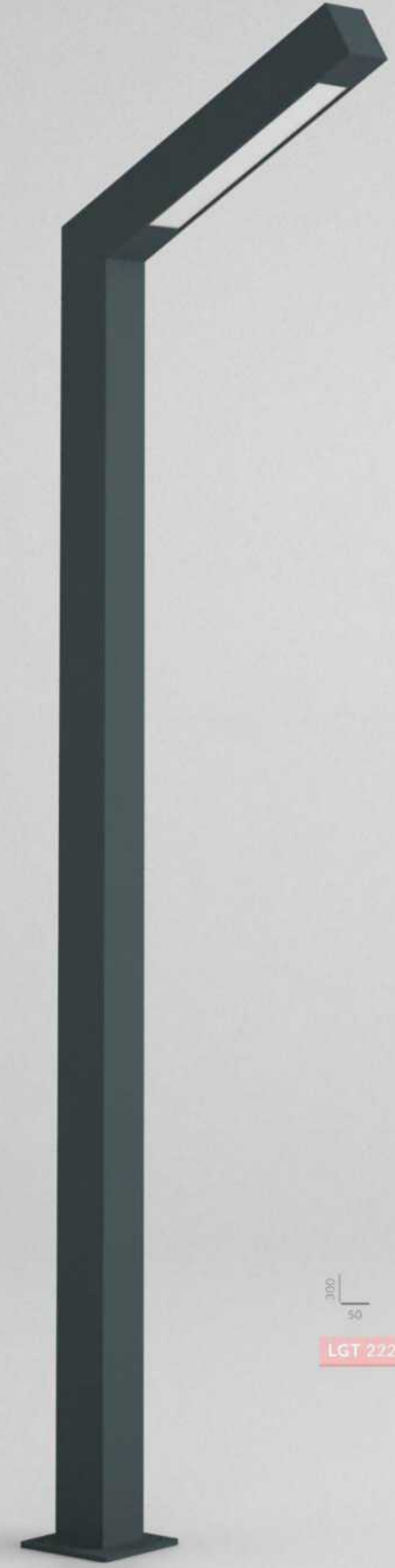

300
50

LGT 222

CE	TSE	ISO 9001:2015	230 V 50 Hz	⏚	IP65	Electrostatic Painting	Aluminium Casting	LED
----	-----	------------------	----------------	---	------	------------------------	-------------------	-----

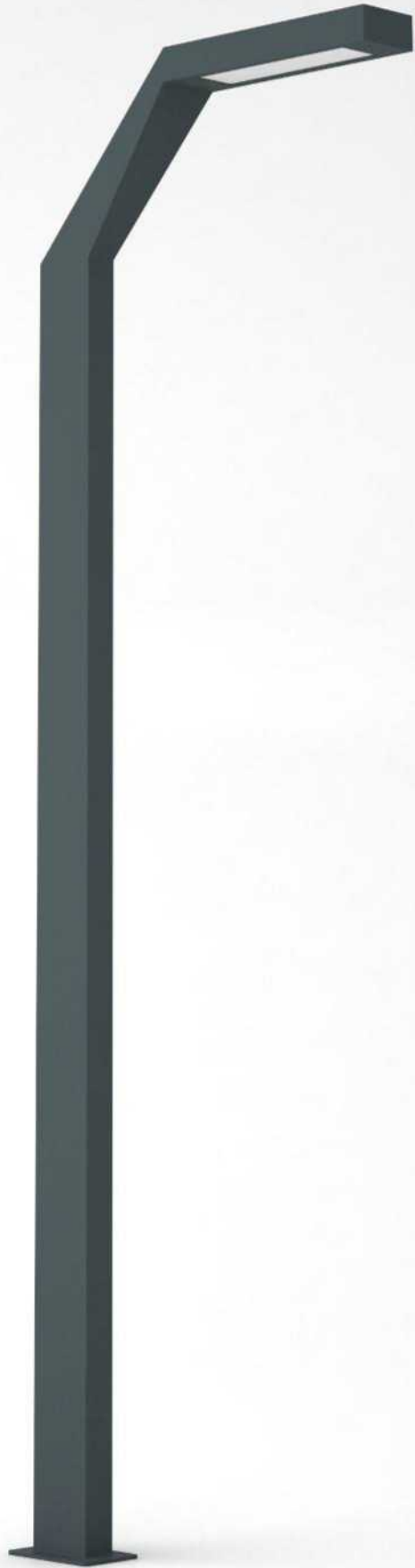

400
100

LGT 223

LED	Aluminium Casting	Electrostatic Painting	IP65	⏚	230 V 50 Hz	ISO 9001:2015	TSE	CE
-----	-------------------	------------------------	------	---	----------------	---------------	-----	----

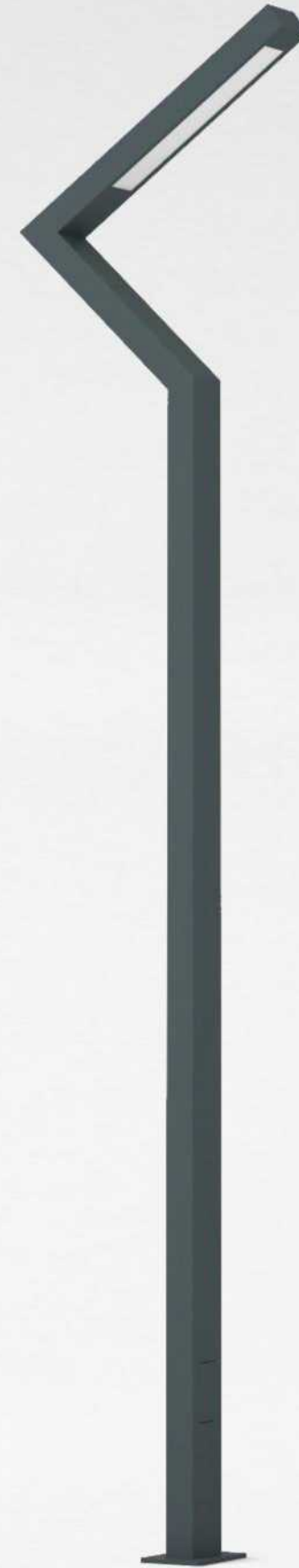

400
100

LGT 224

CE	TSE	ISO 9001:2015	230 V 50 Hz	⏚	IP65	Electrostatic Painting	Aluminium Casting	LED
----	-----	---------------	----------------	---	------	------------------------	-------------------	-----

400
40

LGT 225

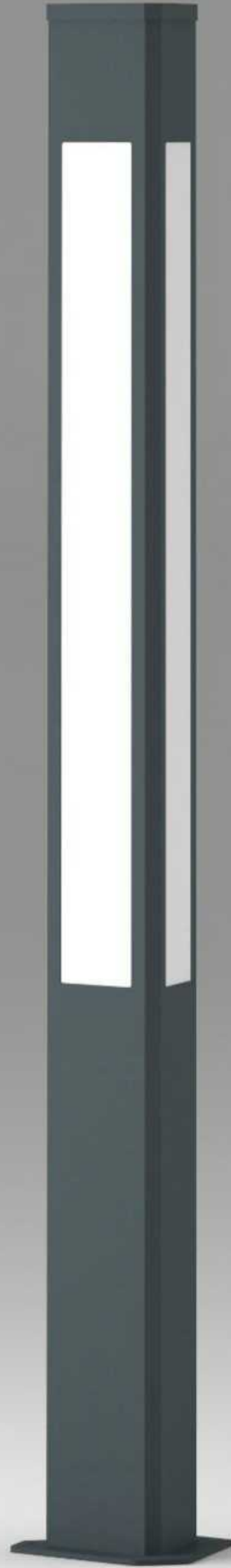

- LED
- Aluminium Casting
- Electrostatic Painting
- IP65
- ⏚
- 230 V 50 Hz
- ISO 9001:2015
- TSE
- CE

400
40

LGT 226



- CE
- TSE
- ISO 9001:2015
- 230 V 50 Hz
- ⏚
- IP65
- Electrostatic Painting
- Aluminium Casting
- LED

400
40
LGT 227



400
40
LGT 228

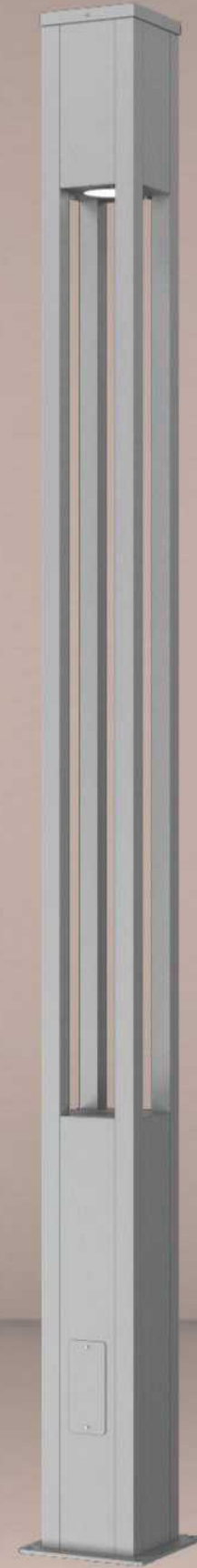

LED Aluminium Casting Electrostatic Painting IP65 230 V 50 Hz ISO 9001:2015 TSE CE

CE TSE ISO 9001:2015 230 V 50 Hz IP65 Electrostatic Painting Aluminium Casting LED



LGT 229

○ RAL 9016 ● RAL 7741 ● RAL 9006 ● RAL 9005

60W	6000lm - 6500lm	3000-4000K
90W	8400lm - 9100lm	3000-4000K
120W	10500lm - 11500lm	3000-4000K

Body: Cast Aluminium Housing

Body: Powder Coating

Diffuser: Clear Tempered Glass

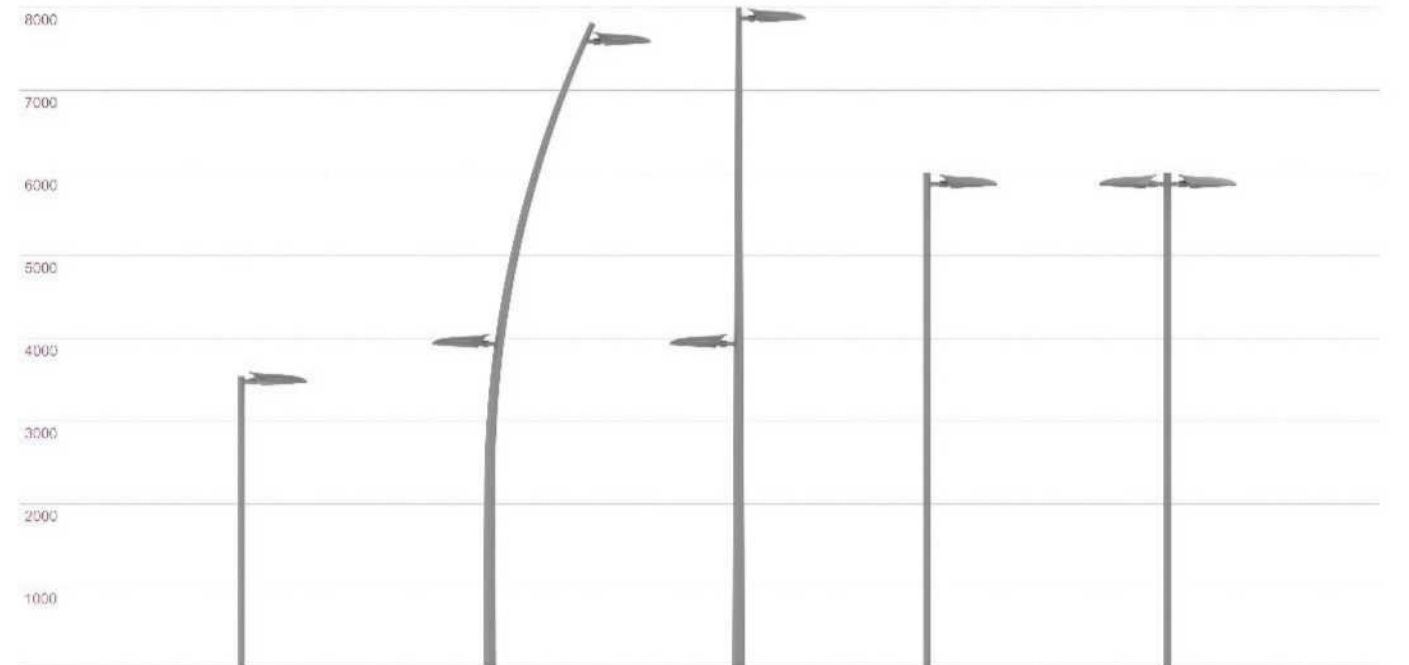
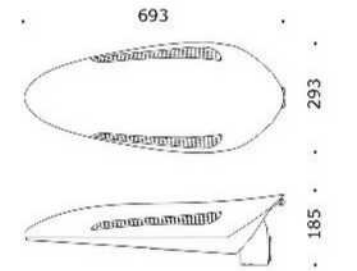
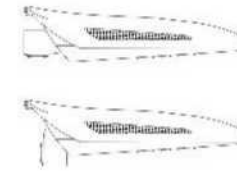



LGT 230

○ RAL 9016 ● RAL 7741 ● RAL 9006 ● RAL 9005

60W

6000lm - 6500lm

3000-4000K

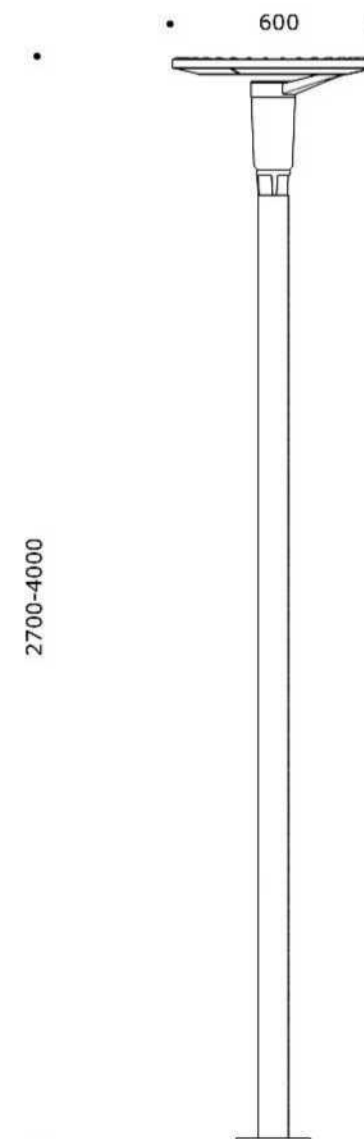

Features

- The main body of St 37 steel pipe
- Hot dip TS 914 EN ISO 1461 Electrostatic Powder Paint Galvanized
- Sub-Qaida aluminum injection casting
- Aluminium Luminaire
- Stainless screws

Armature

- IP 67
- Class II
- Casting
- PMMA

Symmetrical light distribution

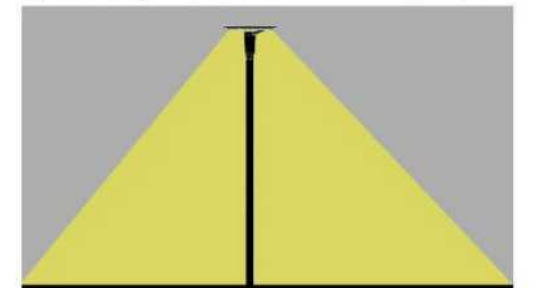



LGT 231

○ RAL 9016 ● RAL 7741 ● RAL 9006 ● RAL 9005

60W	6000lm - 6500lm	3000-4000K
70W	7000lm - 7700lm	3000-4000K

HIT	35-70-150W	A60	44-70W
TC-EL	22-70W	HIT-DE-CE	70-150W
TC-D/E	35-70-70W	HIT-DE	70-150W
		A45	46W

Features

- The main body of St 37 steel pipe
- Hot dip TS 914 EN ISO 1461
- Electrostatic Powder Paint Galvanized
- Sub-Qaida aluminum injection casting
- Aluminium Luminaire
- Stainless screws

Armature

- IP 65
- Class II
- Casting
- Tempered Glass

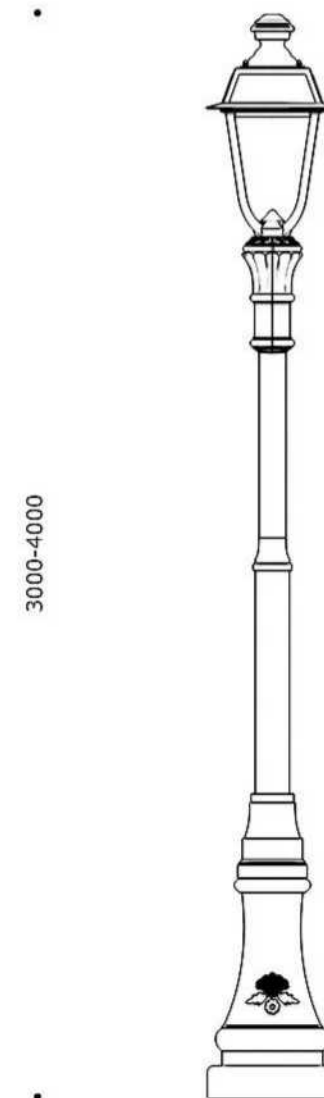

Asymmetrical light distribution











LGT 232

RAL 9016
 RAL 7741
 RAL 9006
 RAL 9005

40W	4000lm - 4400lm	3000-4000K
60W	5900lm - 6600lm	3000-4000K

 HIT	35-70-150W	 A60	44-70W
 TC-EL	22-70W	 HIT-DE-CE	70-150W
 TC-D/E	35-70-70W	 HIST-D/E	70-150W
		 A45	46W

Features

- The main body of St 37 steel pipe
- Hot dip TS 914 EN ISO 1461
- Electrostatic Powder Paint Galvanized
- Sub-Qaida aluminum injection casting
- Aluminium Luminaire
- Stainless screws

Armature

- IP 65
- Class II
- Casting
- Tempered Glass

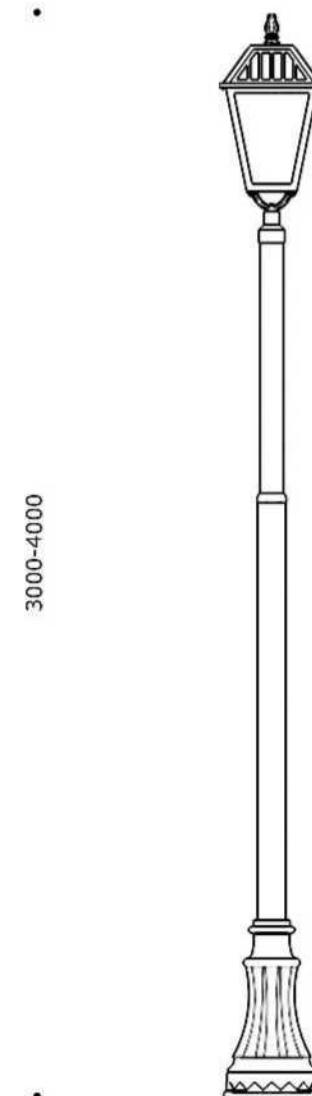

Asymmetrical light distribution





LGT 233

○ RAL 9016 ● RAL 7741 ● RAL 9006 ● RAL 9005

60W	6000lm - 6500lm	3000-4000K
90W	8400lm - 9100lm	3000-4000K
120W	10500lm - 11500lm	3000-4000K

☀️ HIT	35-70-150W 250W	🔍 A60	44-70W
☀️ TC-FL	22-70W	🔍 HIT-DE-CE	70-150W
☀️ TC-D/E	35-70-70W	🔍 HIT-D/E	70-150W
		🔍 A45	46W

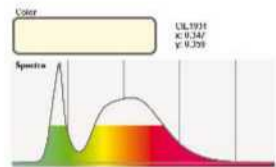
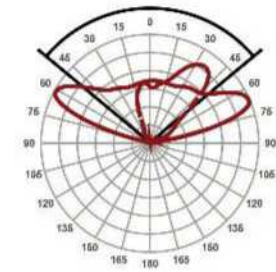

Body: Cast Aluminium Housing

Body: Powder Coating

Diffuser: Clear Tempered Glass

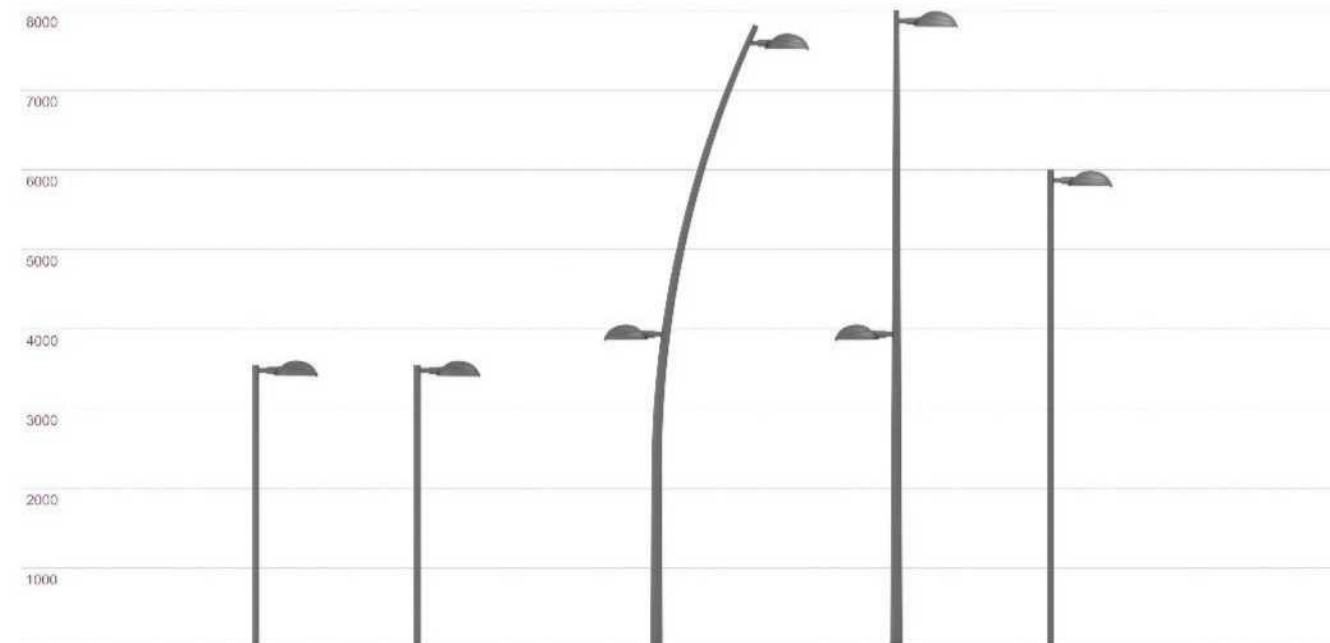
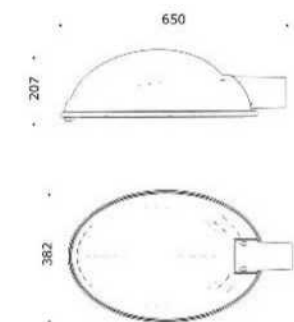



LGT 234

RAL 9016
 RAL 7741
 RAL 9006
 RAL 9005

30W	3000lm - 3400lm	3000-4000K
60W	6000lm - 6500lm	3000-4000K
90W	9000lm - 9900lm	3000-4000K

Features

- The main body of St 37 steel pipe
- Hot dip TS 914 EN ISO 1461 Electrostatic Powder Paint Galvanized
- Sub-Qaida aluminum injection casting
- Aluminium Luminaire
- Stainless screws

Armature

- IP 67
- Class II
- Casting
- PMMA

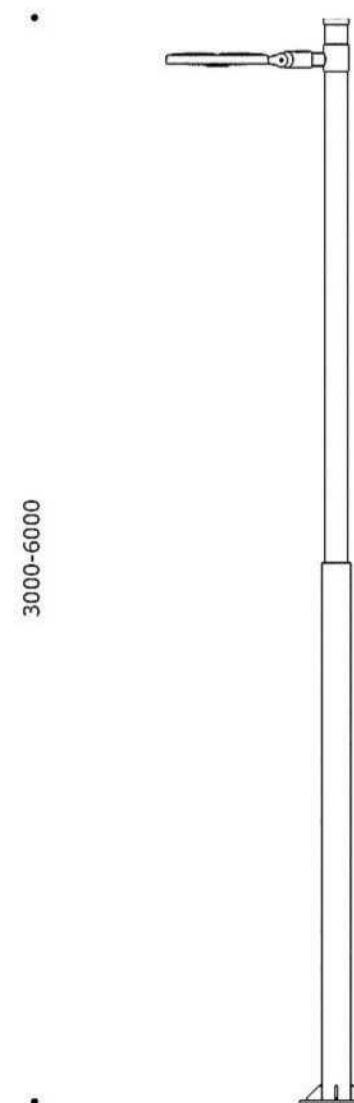

Asymmetrical light distribution

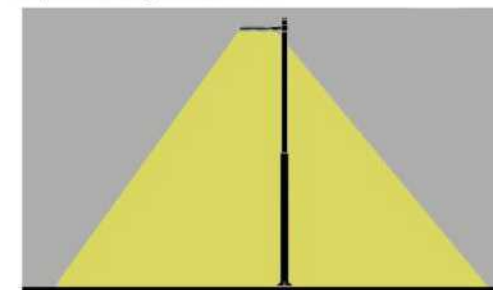



500
175

LGT 235



500
190

LGT 237



500
190

LGT 239



500
175

LGT 241



500
190

LGT 243



500
190

LGT 245



500
175

LGT 236



500
190

LGT 238



500
190

LGT 240



500
175

LGT 242

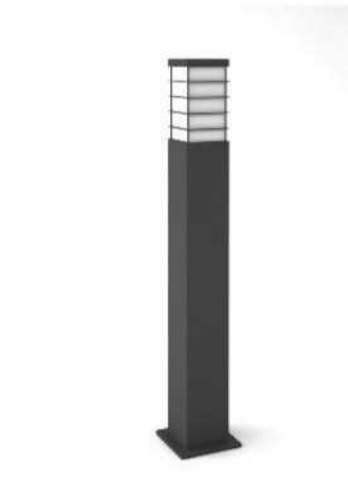

500
190

LGT 244



500
190

LGT 246

LED Aluminium Casting Electrostatic Painting IP65 230 V 50 Hz ISO 9001:2015 TSE CE

CE TSE ISO 9001:2015 230 V 50 Hz IP65 Electrostatic Painting Aluminium Casting LED



500
175

LGT 247



500
190

LGT 249



500
190

LGT 251



500
175

LGT 253



500
190

LGT 255



500
190

LGT 257



500
175

LGT 248



500
190

LGT 250



500
190

LGT 252



500
175

LGT 254



500
190

LGT 256



500
190

LGT 258



E27



Aluminum Casting



Electrostatic Painting

IP55



230 V
50 Hz

ISO
9001:2015



ISO
9001:2015

230 V
50 Hz



IP55



Electrostatic Painting



Aluminum Casting



E27



160
87

LGT 259



140
87

LGT 261



120
50

LGT 263



105
41

LGT 266



105
40

LGT 268



120
80

LGT 260



115
77

LGT 262



106
45

LGT 264



356
90

LGT 265



110
41

LGT 267



120
41

LGT 269



ISO
9001:2015



ISO
9001:2015





86
47

LGT 270



86
47

LGT 272



77
25

LGT 274



90
37

LGT 271



82
29

LGT 273



93
58

LGT 275



KG
300

300
125

LGT 276





80
76

LGT 277



122
41

LGT 279



100
55

LGT 281



54
30

LGT 283



62
25

LGT 285



50
25

LGT 287



115
57

LGT 278



115
57

LGT 280



100
55

LGT 282



80
35

LGT 284



105
32

LGT 286



80
19

LGT 288



ISO
9001:2015



ISO
9001:2015





80
128

LGT 289



80
128

LGT 291



90
110

LGT 293



82
155

LGT 295



79
145

LGT 290



79
150

LGT 292



74
140

LGT 294



93
142

LGT 296



ISO
9001:2015



ISO
9001:2015





83
44

LGT 297



79
46

LGT 299



87
44

LGT 301



73
63

LGT 303



90
73

LGT 304



74
73

LGT 305



80
57

LGT 298



87
42

LGT 300



94
47

LGT 302



73
160

LGT 306



Aluminium Casting



Electrostatic Painting

ISO 9001:2015



ISO 9001:2015



Electrostatic Painting



Aluminium Casting